

Description

- The locking point is a special roller cam designed to reduce friction
The construction of the small corner transmission allows you to have advantage refer to your window dimensions.
- Easy ventilation advantage with usage T-19182 and T-19183 ventilation locking plates.
- The length of the corner transmission is 109 mm
- The transmission is realized with 3 stainless steel springs in the guide.



Material Specification

Body : Steel acc. EN 10149
 Surface : Corrosion resistance up to 500 hours acc. DIN 50021

Technical Drawing

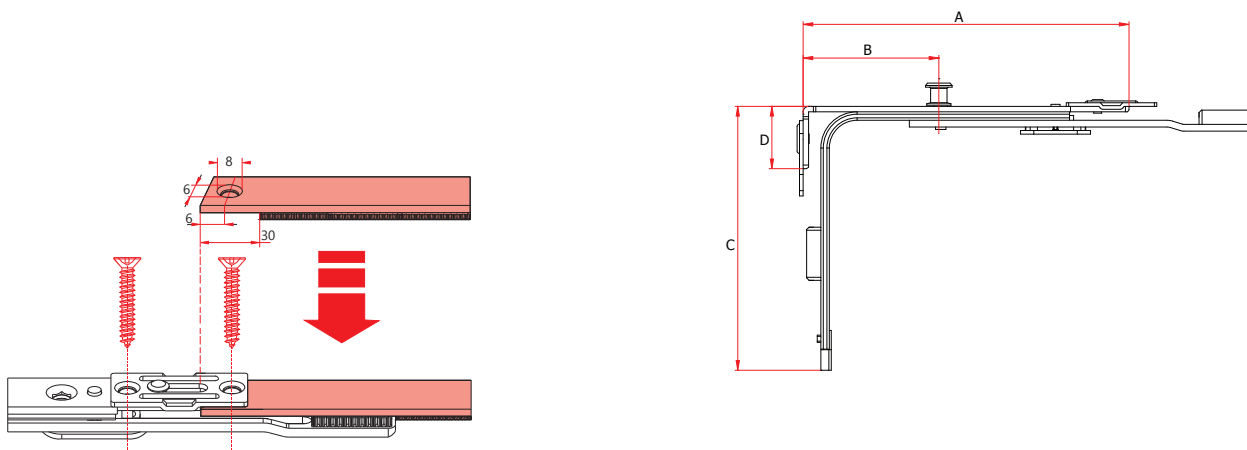

PG	Code	A	B	C	D		
T1	T-10181-04-0-1	135	57	109	26	1	20